

KJT Sensors - KJT-J12 Series

Proximity Sensor - DC Power Supplies

KJT-JT612-D1.5**-DS1250



- Performance more steady due to specialized IC
- Power supply range: 10-36V DC
- Output function : NPN/PNP NO/NC/ NO+NC
- Sensing distance Sn (mm) :1.5mm
- Pressure: 500Bar
- Housing material : Stainless steel
- Protection degree : IP68 (IEC)

Technical parameter

Size	M12*50mm
Mounting	Shielded
Sensing Distance SN [mm]	1.5mm
Housing material	Stainless steel
Pressure endurable	500Bar
Operating voltage	10-36VDC
Output	PNP/NPN NO/NC/ NO+NC
Ripple	<10%
No Load Current	<10mA
Max.Load Current	200mA
Leakage Current	<0.01mA
Voltage Drop	<1.5V
Switching Frequency	1KHz
Response Time	0.5ms
Switching Hysteresis	<15%(Sr)
Repeat Accuracy	<3%(Sr)/<3%(Sr)/<5%(Sr)
Protection Degree	IP68
Operating Temperature	-25℃-+85℃
Temperature Drift	<10%(Sr)
Short Circuit Protection	YES
Overload Trip Point	200mA
Connection	With M12 4 pin connector

KJT Sensors - KJT-J12 Series

Proximity Sensor - DC Power Supplies

KJT-JT612-D1.5**-DS1250

Dimension drawing

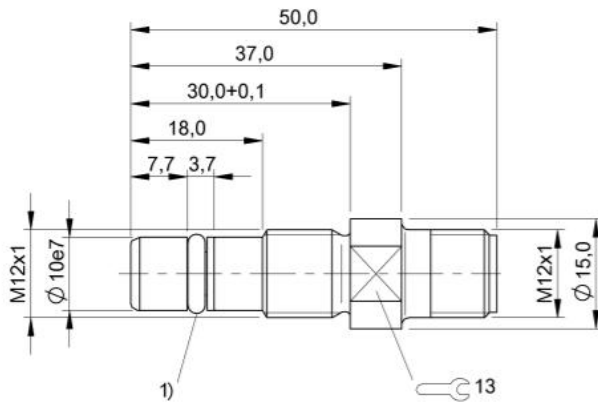

Connection diagram

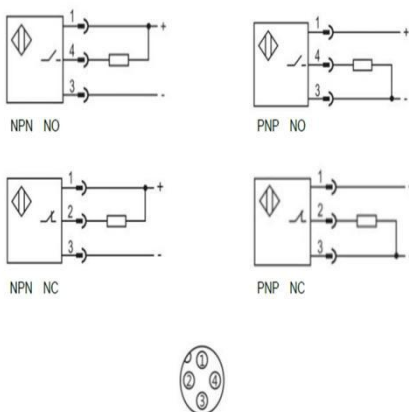

KJT Sensors - KJT-J12 Series

Proximity Sensor - DC Power Supplies

KJT-JT612-D1.5**-DS1250

Model/Order Number	
Sn 1.5mm DC 3 wire 10-36V PNP NO	KJT-JT612-D1.5PA-DS1250
Sn 1.5mm DC 3 wire 10-36V PNP NC	KJT-JT612-D1.5PB-DS1250
Sn 1.5mm DC 3 wire 10-36V NPN NO	KJT-JT612-D1.5NA-DS1250
Sn 1.5mm DC 3 wire 10-36V NPN NC	KJT-JT612-D1.5NB-DS1250
Sn 1.5mm DC 4 wire 10-36V PNP NO+NC	KJT-JT612-D1.5PC-DS1250
Sn 1.5mm DC 4 wire 10-36V NPN NO+NC	KJT-JT612-D1.5NC-DS1250